

20. Lower Inner Trim

A: REMOVAL

1) Remove the hook, and remove the inside scuff plate.

CAUTION:
Do not pull with excessive force. Doing so may damage the scuff plate.

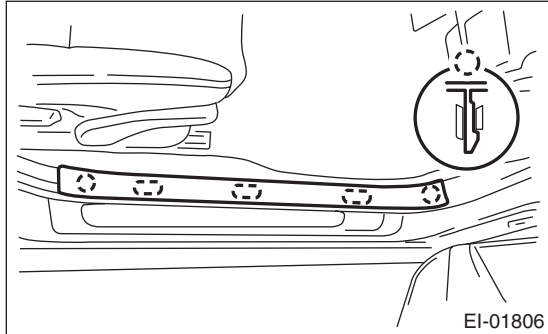

NOTE:
It is easier to remove the weather strip and pull off the floor mat to detach the claw of scuff plate from the backside.

2) Remove the weather strip (A), and remove the outside scuff plate.

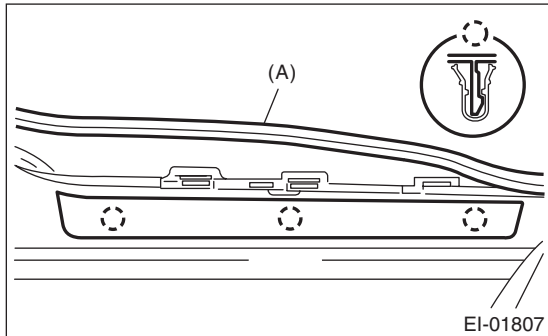

3) Remove clip (A), and remove the front pillar lower trim.

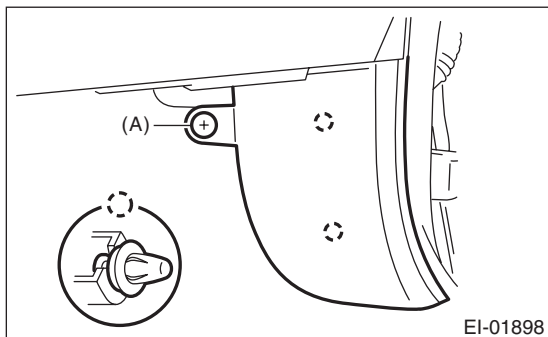

4) Remove the rear seat cushion. <Ref. to SE-13, REMOVAL, Rear Seat.>

5) Remove clip (A), and remove the inside scuff plate.

CAUTION:
Do not pull with excessive force. Doing so may damage the scuff plate.

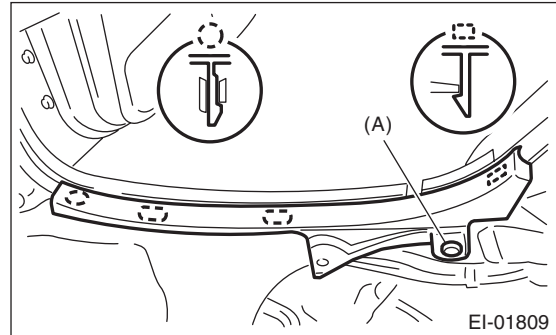

NOTE:

- It is easier to remove the weather strip to detach the claw of scuff plate from the backside of floor mat.
- It is easier to detach the tip claw of scuff plate using a clip remover.

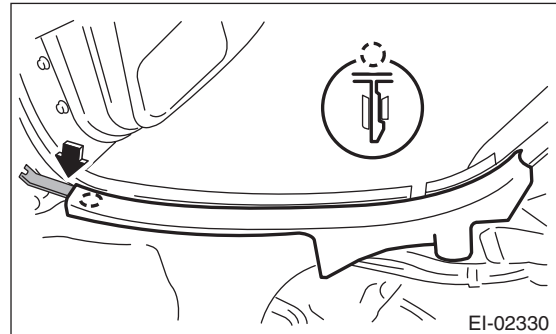

6) Remove weather strip (A) and door catcher cover (B), then remove the outside scuff plate.

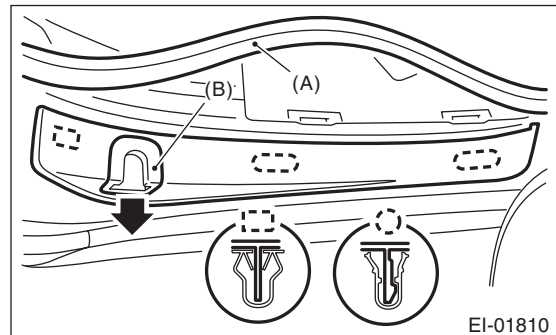

Lower Inner Trim

EXTERIOR/INTERIOR TRIM

7) Remove the clips of the center pillar lower trim.

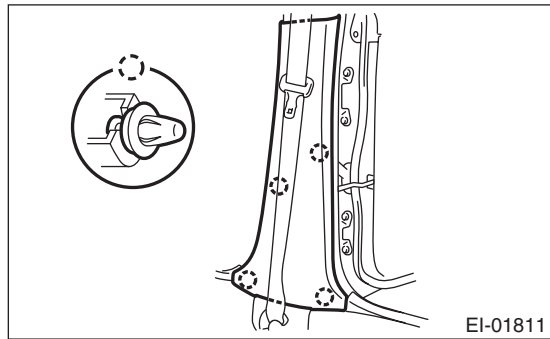

8) Spread the lower trim outwards to remove the claw, and pull on the upper trim to remove.

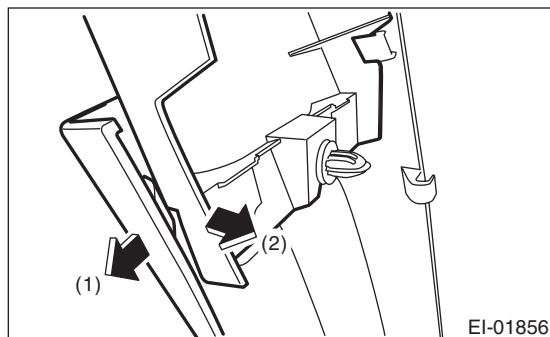

B: INSTALLATION

Install each part in the reverse order of removal.